

Capresso

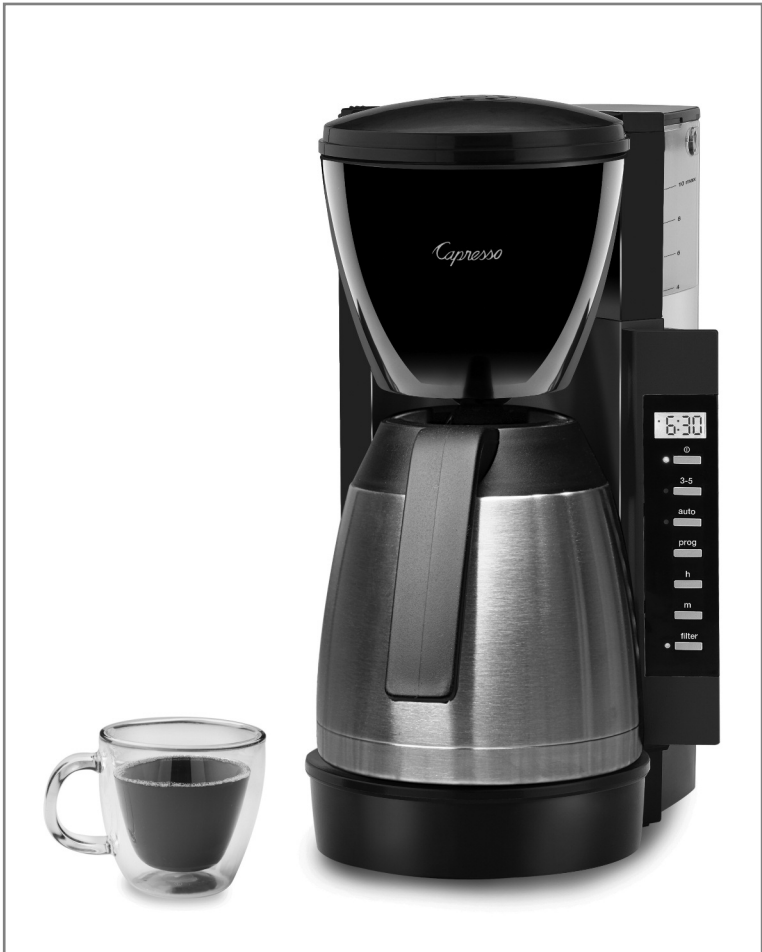

CM300, Model #475

10-Cup Programmable Coffee Maker

- Operating Instructions
- Product Registration
- Warranty

IMPORTANT SAFEGUARDS

When using electrical appliances, basic safety precautions should always be followed, including the following:

1. Read all instructions.
2. Do not touch hot surfaces. Use handles or knobs.
3. To protect against fire, electric shock and personal injury, do not immerse cord, plugs, or appliance in water or other liquid.
4. Close supervision is necessary when any appliance is used by or near children.
5. Unplug from outlet when not in use and before cleaning. Allow it to cool before putting on or taking off parts, and before cleaning the appliance.
6. Do not operate any appliance with a damaged cord or plug or after the appliance malfunctions, or has been damaged in any manner. Return appliance to the nearest authorized service facility for examination, repair or adjustment.
7. The use of accessory attachments not recommended by Capresso may result in fire, electric shock, or personal injury.
8. Do not use outdoors.
9. Do not let the cord hang over the edge of a table or counter, or touch hot surfaces.
10. Do not place on or near a hot gas or electric burner, or in a heated oven.
11. Always attach plug to appliance first, then plug cord into wall outlet. To disconnect, turn any control to "off" then remove plug from wall outlet.
12. Do not use appliance for other than intended use.
13. Scalding may occur if the water container lid is opened during the brewing cycle.
14. For household use only.

SAVE THESE INSTRUCTIONS SPECIAL CORD SET INSTRUCTIONS

Regarding your cord set:

- A. A short power-supply cord (or detachable power-supply cord) is to be provided to reduce risks resulting from becoming entangled in or tripping over a longer cord.
- B. Longer detachable power-supply or extension cords are available and may be used if care is exercised in their use.
- C. If a long detachable power-supply cord or extension cord is used,
 - 1) The marked electrical rating of the detachable power-supply cord or extension cord should be at least as great as the electrical rating of the appliance,
 - 2) If the appliance is of the grounded type, the extension cord should be a rounding type 3-wire cord, and

3) The longer cord should be arranged so that it will not drape over the counter top or table top where it can be pulled on by children or tripped over.

D. This appliance has a polarized plug (one blade is wider than the other). As a safety feature, this plug will fit in a polarized outlet only one way. If the plug does not fit fully in the outlet, reverse the plug. If it still does not fit, contact a qualified electrician. Do not attempt to defeat this safety feature.

CAUTION

This appliance is for household use. Any servicing other than cleaning and user maintenance should be performed by an authorized service representative.

- Do not immerse base in water or try to disassemble.
- To reduce the risk of fire or electric shock, do not remove the base. No user serviceable parts inside. Repair should be done by authorized service personnel only.
- Check voltage to be sure that the voltage indicated on the name plate agrees with your voltage.
- Never use warm or hot water to fill the water container! Use cold water only!
- Keep your hands and the cord away from hot parts of the appliance during operation.
- Never clean with scouring powders or hard implements.

Welcome and Thank You

Thank you for choosing the Capresso CM300. The charcoal water filtration indicator takes the guess work out of replacing the charcoal insert at the right time. The removable water container makes filling convenient. **Please read all operating instructions before using your CM300.** Understanding and complying with these directions is essential to ensure that the machine is utilized without risk and to ensure safety during operation and maintenance.

How To Contact Capresso Customer Service

Should you require further information or if particular problems occur that are not covered in this manual, please

- CALL our toll free HELP LINE: 1-800-767-3554 Monday-Thursday 8AM to 9PM, Friday 8AM to 8PM and Saturday 9AM to 5PM Eastern Standard Time. Feel free to call at any time. If you are connected to our voicemail, PLEASE DO NOT HANG UP. Leave your name, telephone number and time to call back. Please leave the name or model number of you Capresso product, in this case it is CM300, Model #475.
- FAX us at 1-201-767-9684 • E-MAIL us at contact@capresso.com
- VISIT our website at www.capresso.com
- WRITE to JURA Inc., Customer Service
P.O. Box 775, Closter, NJ 07624

Capresso CM300, Model #475 Product Registration

- Please go to our website www.capresso.com to register your product. Your information will help us to better serve you.

Important Safeguards	2
Welcome and Thank You	3
How to Contact Capresso Customer Service	3
Product Registration	3
Line Drawings (Figures 1-7).....	5, 6
1. Equipment.....	7
2. Preparing the Coffee Maker	7
a. Before First Use	7
b. The Display / Setting the Clock and the Timer	7
c. To Set the Current Time.....	7
d. To Set an Auto-On Time.....	7
3. The Charcoal Filter Indicator	7
a. Using the Charcoal Water Filter.....	7
b. Replacing the Cartridge / Resetting the Filter Indicator	8
4. The Proper Sequence for Making Coffee.....	8
5. Making Coffee.....	9
a. Using the GoldTone Filter	9
b. Using Filter Paper	9
c. How Much Coffee?.....	9
d. Using the Stainless Steel Carafe.....	9
e. Turning the Coffee Maker On	9
f. Serving Coffee	9
g. Pouring Coffee While Brewing.....	10
h. Brewing Small Amounts of Coffee	10
i. Making Multiple Carafes of Coffee	10
6. Automatic Brewing at a Pre-Programmed Time	10
7. Handling of the Stainless Steel Thermal Carafe	10
a. Cleaning the Stainless Steel Thermal Carafe	10
8. Cleaning the Coffee Maker	11
9. Decalcifying	11
a. How to Decalcify with White Vinegar	11
b. Using other Decalcifying Agents	11
10. Troubleshooting	11
Limited One Year Warranty	back cover

FIG. 1

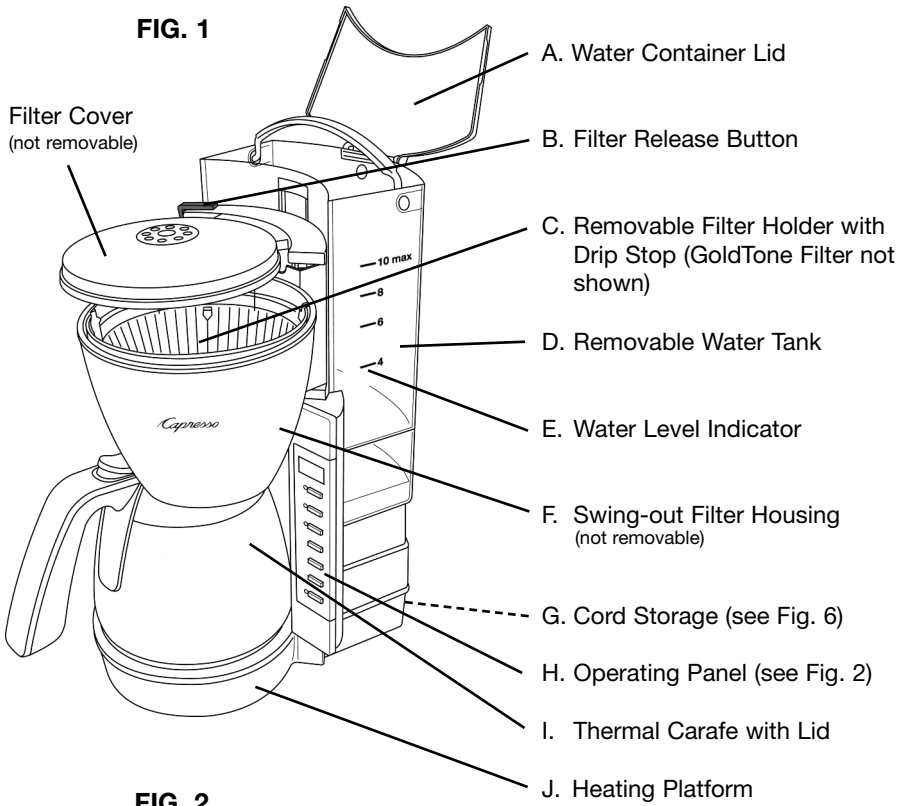
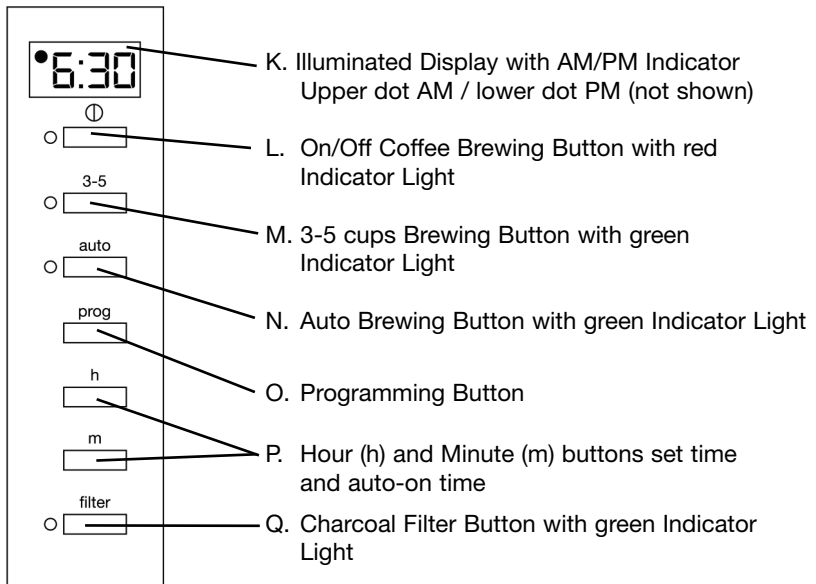

FIG. 2



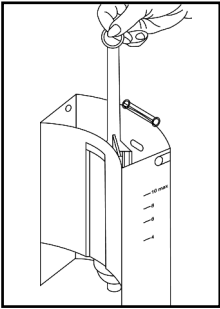

FIG. 3

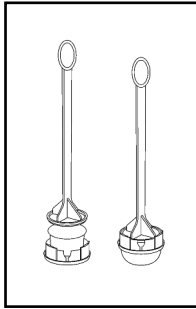

FIG. 4

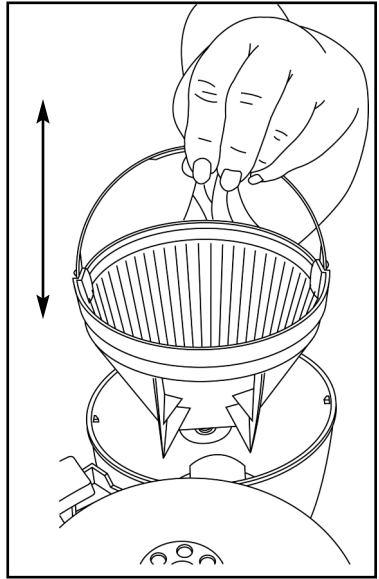

FIG. 7

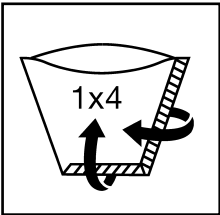

FIG. 5

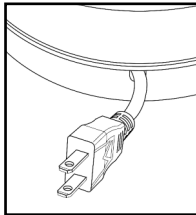

FIG. 6

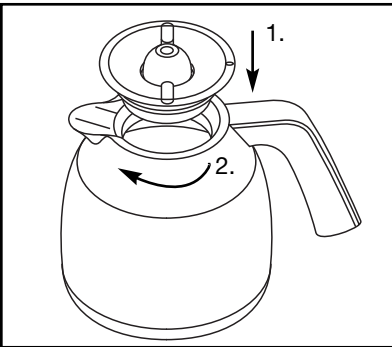

FIG. 8

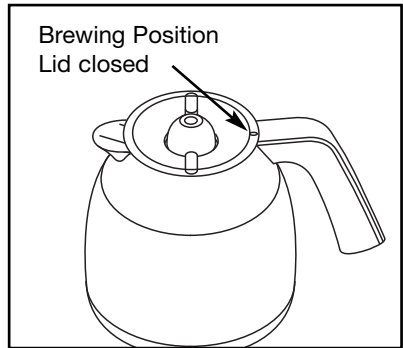

FIG. 9

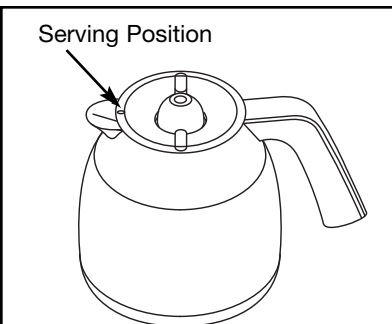

FIG. 10

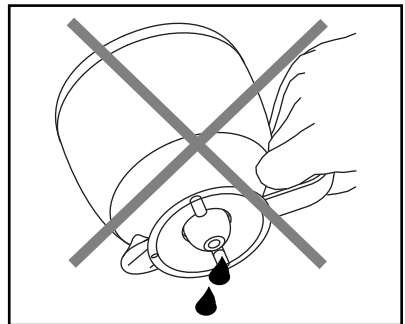

FIG. 11

1. Equipment

The Capresso CM300 comes complete with: Thermal Carafe with Lid

- Measuring Scoop
- GoldTone Filter (inserted in removable Filter Holder)
- Charcoal Filter with Charcoal Filter Holder
- Instruction Book

2. Preparing the Coffee Maker

2a. Before First Use

After unpacking your coffee maker clean all the loose parts with warm water and make yourself familiar with the different functions. After reading these instructions, clean the internal parts of the machine by making two carafes using only water, without any ground coffee inside the filter.

2b. The Display / Setting the Clock and Timer

When you plug in the coffee maker the display (Fig. 2, K) will illuminate for about 30 seconds and will flash "12:00". All indicator lights will be off.

2c. To Set the Current Time (Fig. 2)

Push and hold the hour button. The hours will advance. The little dot on the left upper side (indicating AM) changes to a left lower dot (indicating PM). When the correct hour shows up release the button and push and hold the minute button to set the minutes.

Attention: You must change the clock when the time changes (Standard Time, Daylight Savings Time).

2d. To Set an Auto-On Time:

If you want the coffee maker to start brewing at a preset time automatically, first push the program button (Fig. 2, O). The display shows "12:00". Immediately start pushing the hour and minute buttons as described above until the desired time shows up. Within a few seconds the display will revert to the actual time.

To check the programmed time

just push the program button. The display shows the programmed time and will switch back to the actual time.

To change the programmed time, push the program button and repeat as described above.

Attention: Flashing Display!

If you unplug the coffee maker for more than 10 seconds or if you have a power failure, you will lose the current time and program settings. The flashing display indicates that you must reset the current and programmed time.

3. The Charcoal Filter Indicator

To start the electronic charcoal indicator, push the Filter Button (Fig. 2, Q). The green indicator light for the charcoal filter will turn on.

If you use spring water, bottled water or distilled water and make coffee right away, it is not necessary to use the charcoal filter. Push the Filter Button (Fig. 2, Q) and the green filter indicator light will turn off.

Attention: Spring water and distilled water might attract impurities when sitting in the water container overnight. The charcoal filter will remove most of these impurities since the water will be filtered just before entering the heating element.

3a. Using the Charcoal Water Filter

Most tap water is treated with chlorine. The charcoal filter removes up to 82% of the chlorine and other impurities found in tap water, improving the taste of water substantially. The charcoal cartridge sits in the charcoal holder (see Fig. 4). The charcoal holder is already inserted into the water container.

To activate the charcoal cartridge pour four cups of water into the water container and let it sit for approx. 3 minutes. Then turn the machine on and let the water brew into the carafe (see chapter 4). Discard the water.

As long as the green Charcoal Filter Light is on, the machine monitors time and the number of brewings.

The green charcoal filter light will start blinking either after 6 weeks or after the Coffee Brewing Button has been turned on 60 times whichever comes first, reminding you to replace the cartridge.

If you make coffee once a day, the filter light will start flashing after 6 weeks. If you make coffee twice a day, the light will flash after 30 days. This will help you to plan the right amount of cartridges.

Attention: When you unplug the machine for more than 10 seconds or if you have a power failure, the electronic indicator loses its memory. Then it is best to replace the filter 6 weeks after first use.

Caution: Once the cartridge is activated you should never use it for longer than six weeks. Harmful bacteria build-up may occur. Unused cartridges can be stored indefinitely.

Replacement cartridges are available through your local Capresso dealer or through the website: www.capresso.com.

3b. Replacing the Cartridge / Resetting the Filter Indicator

Remove the cartridge from the water container (Fig. 3), twist and open the holder and discard the old cartridge. Replace with new cartridge (Fig. 4) and close the filter holder securely. Insert the assembly back into the water tank (Fig. 3) and make sure it is inserted properly otherwise the water container lid will not close completely. Activate the charcoal filter (chapter 3a).

While the green light is still blinking, push and hold the Charcoal Filter Button for a few seconds until the light stops blinking and is illuminated. The indicator starts counting again.

4. The Proper Sequence for Making Coffee

Coffee makers produce very hot water. If you follow the sequence as described below you will avoid possible accidents which might cause severe injuries and burns.

1. Remove carafe from machine.
2. Remove the water container and fill with the desired amount of water. Do not fill above the MAX setting. Replace the water container and make sure it sits firmly in place.
3. Push the Filter Release button (Fig 1, B) so that the filter holder housing swings to the right. Make sure the filter holder insert sits firmly in place with the handle pushed down.

Caution: When you push against the drip stop from the bottom, and the filter holder lifts up, re-insert the filter holder. Otherwise the drip stop will not open during brewing. Hot water could overflow from the filter causing injuries.

4. Insert filter paper (chapter 5b) or a GoldTone Filter (chapter 5a).
5. Add the correct amount of ground coffee (chapter 5c).
6. Swing the filter holder back into the machine. Make sure it engages under the Filter Cover (Fig. 1).
7. Make sure the thermal carafe is empty and the lid of the thermal carafe is completely closed (Fig. 9).
8. Turn the machine on (Fig. 2, L).
9. Never push the Filter Release Button during brewing. Hot water could spill out causing burns. Wait until the brewing noise stops.
10. Immediately after brewing is finished there could still be hot water in the filter holder passing through the ground coffee. This can take 1 to 3 minutes depending on how much coffee you used and how fine the coffee was ground.

5. Making Coffee

Please follow the steps described in chapter 4.

Stainless Steel Thermal Carafe:

When you use the thermal carafe for filling the water tank, the inside of the carafe will be cold from the cold water. We highly recommend removing the water tank and filling it directly. If you fill the water tank from the carafe we suggest rinsing the carafe with hot water. This will increase the coffee temperature and will keep the coffee hot longer

5a. Using the GoldTone Filter

A size 4 GoldTone filter comes with the machine. It sits in the Filter Holder.

Attention: Coffee flows slower through a GoldTone Filter than through paper filters. Please see the chart in chapter 5c for maximum coffee amounts.

5b. Using Filter Paper

Use size 4 paper only. Always fold the bottom and side crimps over for a proper fit (see Fig. 5). Do not use a filter paper inside a GoldTone Filter!

5c. How Much Coffee?

A coffee scoop comes with your coffee maker. We recommend using one level scoop of coffee per cup. If you like your coffee extremely strong never use more coffee than the amounts indicated in the chart shown.

Maximum # of Scoops	GoldTone Filter	Size 4 Paper Filter
Regular or Drip Grind (Supermarket Version)	12 scoops	14 scoops
Fine Grind (finer than Drip Grind)	8-10 scoops	9-11 scoops

Using more coffee can result in an overflow of ground coffee, above the filter, blocking the drip stop function and causing a mess on your counter.

5d. Using the Stainless Steel Carafe

For best coffee temperature pre-warm the carafe by rinsing it with hot water. Always make sure carafe is completely empty. Place the lid on top of the carafe as shown in Fig. 8 (pay attention to the position of the black dot on the lid) and turn clockwise until the lid cannot be turned anymore and the dot points towards the handle (Fig. 9). This is the brewing position.

Caution: Make sure the lid is not in the pouring position (Fig.10). This could result in the Filter Holder popping up. The drip stop will not work and hot coffee could overflow from the filter holder.

Attention: Please note that the lid must always be on the carafe and closed (Fig. 9) during brewing to activate the drip stop. **If you lose the lid, you cannot brew coffee.** Please call 1-800-767-3554 to order a new lid or order online at: www.cappresso.com.

5e. Turning the Coffee Maker On

Push the On/Off button (Fig. 2, L). The red light will illuminate, indicating that the brewing process is starting.

Caution: Never push the Filter Release Button during brewing (Fig. 1, B).

5f. Serving Coffee

Brewing time for a full pot of coffee takes just about 9 minutes. When all the water is passed through, the red indicator light remains on for approx. two minutes then turns off. The machine is now off. Remove the carafe from the platform. Turn the lid counterclockwise 180 degrees until the black dot is over the pouring spout (Fig. 10). You can now pour coffee. After serving make sure to close the lid again to prevent heat from escaping from the carafe.

It is extremely important that the carafe lid is in the correct position when brewing and when pouring. Please refer to Fig. 9 and Fig. 10 for correct positioning of carafe lid.

5g. Pouring Coffee While Brewing

You can remove the carafe from the platform during the brewing process for approx. 20 seconds to pour a cup before brewing is finished.

Important: Make sure to open and close the carafe lid as indicated in chapter 5d.

5h. Brewing Small Amounts of Coffee

When brewing small amounts of coffee (3 to 5 cups) push the 3-5 cup button first (Fig. 2, M). The green indicator light will go on. Then push the On/Off button. The red indicator light will go on. The brewing process will be slowed down to allow the coffee to reach its full aroma.

If you pushed the 3-5 cup button by mistake, just push it again to turn off this function.

Important: When brewing 3-5 cups of coffee the temperature in the carafe will be approx. 3 to 5 degrees lower than on a full pot.

5i. Making Multiple Carafes of Coffee

If you want to make another carafe of coffee immediately after the first pot, make sure the machine is off and allow to cool down for three minutes before refilling the water tank.

Important: Make sure the carafe is empty before brewing.

6. Automatic Brewing at a Pre-Programmed Time

Set the programmed time at which you wish to brew coffee as described in chapter 2d.

Make sure that the programmed time is correct (AM or PM).

Hint: If you want your coffee ready by 7:15 AM, set the programmed time to 7:05, i.e. 10 minutes earlier. This way you get the freshest and hottest coffee possible.

Important: Avoid any air conditioner blowing cold air against the thermal carafe. This will cool down the carafe

overnight and reduce the coffee temperature in the carafe.

Fill the water tank and filter holder and place the empty carafe with the closed lid on the platform (chapter 4).

Push the "auto" button (Fig. 2, N).

The green indicator light will go on. At the pre-programmed time, the red on button will go on and the green auto light will go off, indicating that brewing has started.

Important: If you pushed the auto button by mistake just push it again to turn it off.

7. Handling of the Stainless Steel Thermal Carafe

The lid of the thermal carafe has a pouring indentation to make it possible to pour with the lid in place (black dot pointing at the spout, Fig. 10). Always make sure that the carafe is transported in an upright position. If you turn the carafe with its lid closed on its side or turn it upside down, hot coffee will flow into the grooves of the lid and exit through the side of the lid (Fig. 11).

Important: A stainless steel bottom covers the vacuum seal of the stainless steel body. Do not try to remove this cover. Do not place the carafe on any hot surfaces since this can loosen the vacuum seal inside the bottom. This can cause the carafe to lose its thermal function. **Do not place carafe in dishwasher.**

7a. Cleaning the Stainless Steel Thermal Carafe

Never immerse carafe completely in hot water or any other liquid. Wipe outside with a non-abrasive wet cloth and dry. Fill inside with hot water and a mild detergent and scrub with a non-abrasive household brush. Rinse thoroughly. **Do not place carafe in dishwasher.**

8. Cleaning the Coffee Maker

- Make sure coffee maker is turned off (Red light is off). Always unplug the appliance from the outlet and allow to cool down before cleaning.
- Never use scouring agents.
- Never immerse the appliance in water or any other liquid and never clean under running water. To clean the appliance, wipe off with a soft, damp cloth.
- **Dishwasher safe** (upper rack) are: Filter Holder, GoldTone Filter.
- Clean the GoldTone Filter after every use. Otherwise coffee oils will form and clog up the small filter openings. Old, hardened coffee oils can spoil the taste of your coffee.
- Clean the lid of the carafe under running water.
- Drip-stop in filter holder: make sure that the drip-stop is free of any coffee particles, otherwise it might not close properly when removing the carafe.

9. Decalcifying

Decalcify at least every 6 months or when brewing ten cups takes more than 10 minutes.

Attention: Before decalcifying, remove the GoldTone filter and Charcoal filter from the machine.

9a. Decalcifying with White Vinegar

- Remove GoldTone filter and Charcoal filter.
- Fill the water container with 20 to 24 oz. of white household vinegar.
- Place the empty carafe with the lid closed underneath the filter holder.
- Turn the machine on for 2 minutes.
- Turn machine off and let sit for 15 minutes.
- Turn machine on again and let the remaining vinegar pass through.
- Turn the coffee maker off (Fig. 2, L), remove the carafe and water tank, empty and rinse a few times with fresh cold water.

- Rinse the filter holder thoroughly with fresh water.
- Let the coffee maker cool down for a few minutes.
- Fill 20 to 24 oz. of fresh cold water into the water tank and brew through machine to remove any vinegar odors.
- Turn off coffee maker and empty carafe.

9b. Using other Decalcifying Agents

Only use decalcifying agents suitable for drip coffee makers, like Capresso Cleaning Solution and follow the instructions which come with the agent.

10. Troubleshooting

What to do if...

...Coffee drips from the filter, when the carafe is removed.

- *Ground coffee sits in the drip stop and does not allow the drip stop to close properly. Immediately replace the carafe and wait until all the coffee has been filtered in the carafe. Now remove carafe and remove the Filter holder. Clean filter holder under running water. Push the drip stop several times to remove coffee particles. Over the sink fill some water into the filter holder and check if the drip stop closes properly.*

...Ground coffee is flowing over the GoldTone Filter.

- *Coffee is ground too fine.*
- *Use less coffee the next time (chapter 5c).*
- *Use a paper filter (size 4) instead of the GoldTone Filter.*

Limited One Year Warranty

This warranty covers your Capresso Coffee Maker CM300, Model #475. The model # can be found on the bottom of the machine. This warranty is in effect for one year from the date of the first consumer purchase.

Transport: When sending the machine, use the original packing materials, the inner and outer cartons or use approximately 2" of bubble wrap and secure the machine properly. Any damage in transit is NOT covered by this warranty.

This warranty does not cover:

- Any machine not purchased from an Authorized Dealer.
- Commercial use of machine.
- Damage caused by accident, abuse, negligence, misuse, improper operation or failure to follow instructions contained in this manual.
- Any service or alteration performed by an unauthorized person, company or association.
- Damage caused by neglecting and omitting maintenance, cleaning and decalcifying.
- Carafes (Glass or Thermal).
- Charcoal Filters.

Other limitations and exclusions:

Any implied warranties including fitness for use and merchantability are limited in duration to the period of the express warranty set forth above and no person is authorized to assume for JURA any other liability in connection with the sale of the machine. JURA expressly disclaims liability for incidental and consequential damages caused by the machine. The term "incidental damages" refers to the loss of the original purchasers time, loss of the use of the machine or other costs relating to the care and custody of the "consequential damages" refers to the cost of repairing or replacing other property which is damaged when this machine does not work properly. The remedies provided under this warranty are exclusive and in lieu of all others. This warranty gives you specific legal rights, and you may also have other rights which vary from state to state.