

# Capresso



## EspressoPRO Model #112

- Operating Instructions
- Product Registration
- Warranty

# IMPORTANT SAFEGUARDS

When using electrical appliances, basic safety precautions should always be followed, including the following:

1. Read all instructions.
2. Do not touch hot surfaces. Use handles or knobs.
3. To protect against fire, electric shock and injury to persons, do not immerse cord, plugs, or body of machine in water or other liquid.
4. Close supervision is necessary when any appliance is used by or near children.
5. Unplug from outlet when not in use and before cleaning. Allow to cool before putting on or taking off parts, and before cleaning the appliance.
6. Do not operate any appliance with a damaged cord or plug or after the appliance malfunctions, or has been damaged in any manner. Return appliance to the nearest authorized service facility for examination, repair, or adjustment.
7. The use of accessory attachments not recommended by the appliance manufacturer may result in fire, electric shock, or injury to persons.
8. Do not use outdoors.
9. Do not let the cord hang over the edge of a table or counter, or touch hot surfaces.
10. Do not place on or near a hot gas or electric burner, or in a heated oven.
11. Always attach plug to appliance first, then plug cord into the wall outlet. To disconnect, turn any control to "OFF", then remove plug from wall outlet.
12. Do not use appliance for other than intended use.
13. Use extreme caution when disposing hot steam.
14. For household use only.

---

## SAVE THESE INSTRUCTIONS

### SPECIAL CORD SET INSTRUCTIONS

1. A short power supply cord is provided to reduce the risk resulting from becoming entangled in or tripping over a long cord.
2. Longer extension cords are available and may be used if care is exercised in their use.
3. If an extension cord is used,
  - a. the marked electrical rating of the extension cord should be at least as great as the electrical rating of the appliance, and
  - b. the longer cord shall be arranged so that it will not drape over the counter top or tabletop where it can be pulled on by children or tripped over.

**fig. 1**

# EspressoPRO User Components

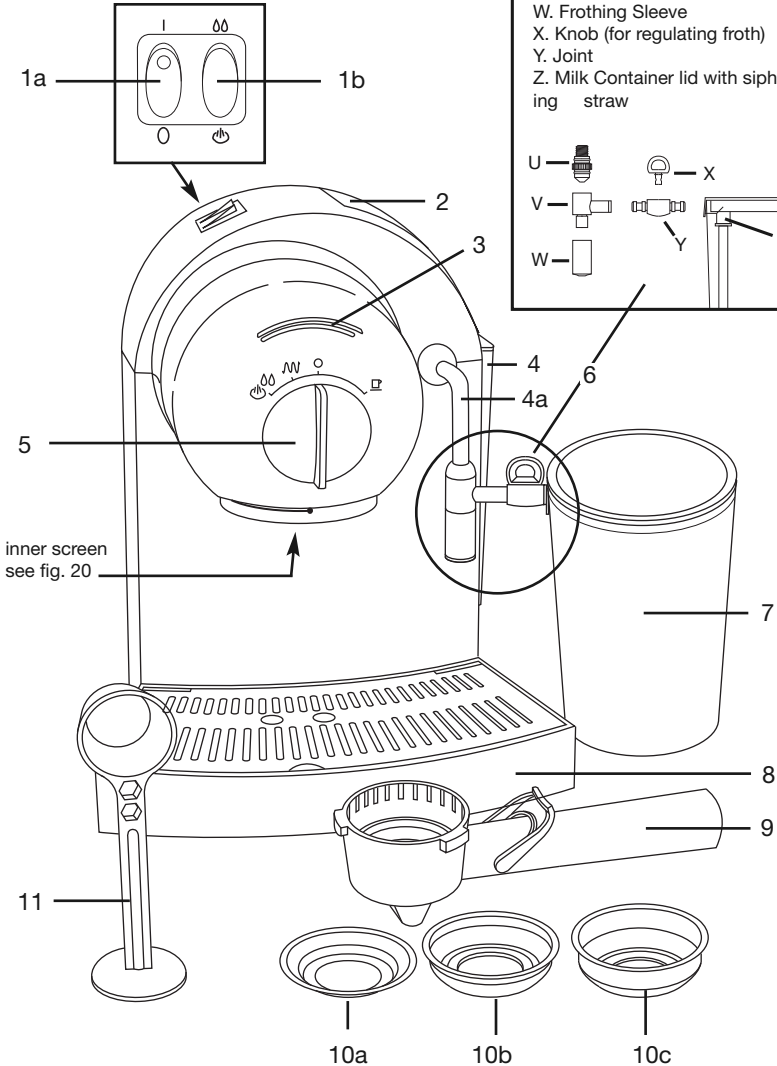

**frothXpress Assembly**

- U. Steam Nozzle
- V. Connector
- W. Frothing Sleeve
- X. Knob (for regulating froth)
- Y. Joint
- Z. Milk Container lid with siphoning straw

**fig. 1d**

- 1a On/Off switch with red indicator light
- 1b Selector switch for hot water or steam
- 2 Lid for water container
- 3 Thermostat Light
- 4 Water container, removable
- 4a Steam tube
- 5 Selector knob
- 6 frothXpress System (fig. 1d)
- 7 Milk container with lid and straw
- 8 Drip tray with grid, removable
- 9 Porta filter
- 10a Pod sieve
- 10b Small sieve, one cup
- 10c Large sieve, two cups
- 11 Measuring scoop with tamper

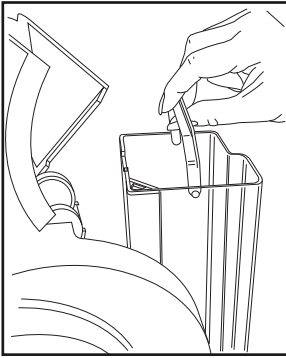

fig. 2

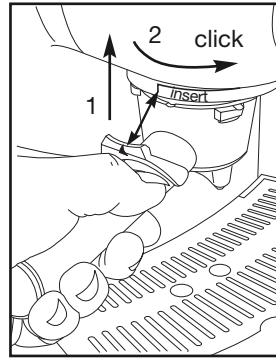
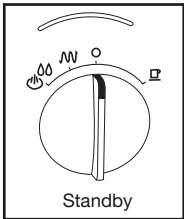

fig. 3



Standby

fig. 5



Brewing Coffee

fig. 6

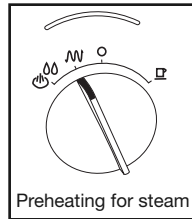

Preheating for steam

fig. 7

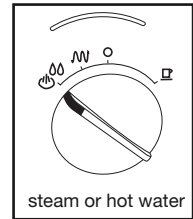

steam or hot water

fig. 8

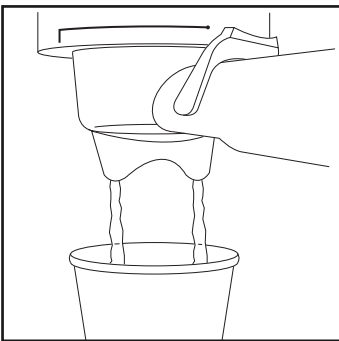

fig. 11

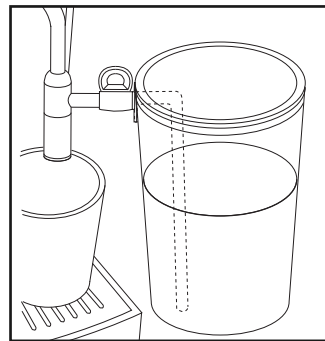

fig. 12

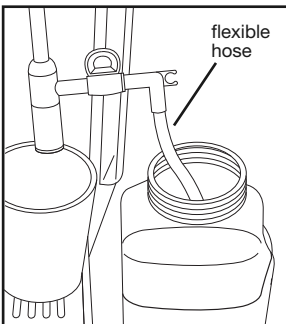

fig. 16

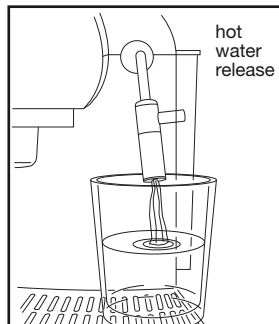

fig. 17

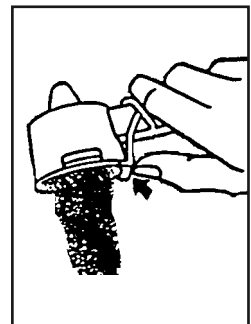

fig. 18

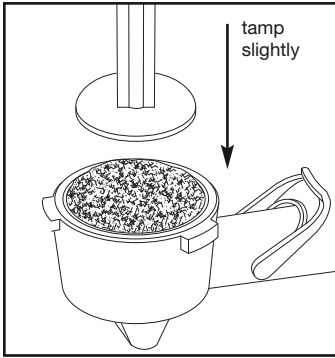

fig. 4

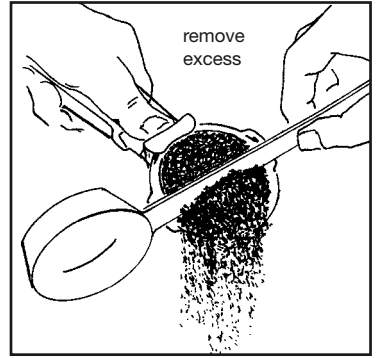

fig. 4a

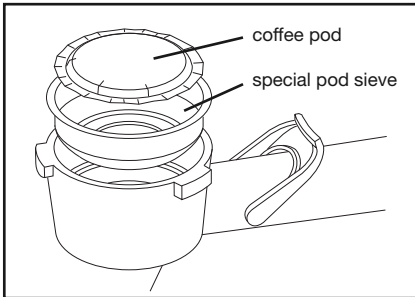

fig. 9

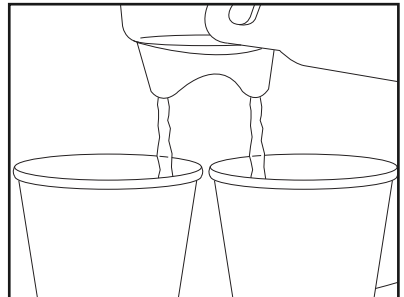

fig. 10

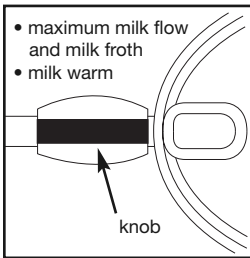

fig. 13

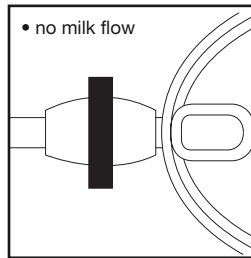

fig. 14

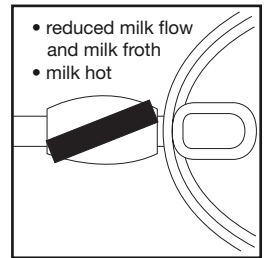

fig. 15

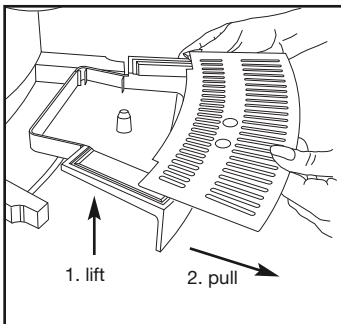

fig. 19

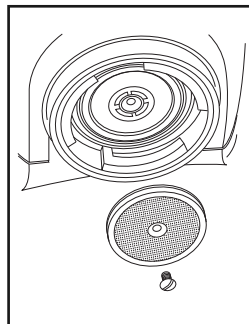

fig. 20

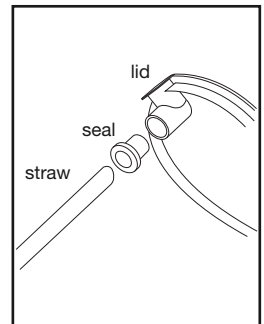

fig. 21

**CONTENTS**

Section	Page
IMPORTANT SAFEGUARDS .....	2
LINE DRAWINGS (FIGURES 1-21) .....	3-5
WHO IS CAPRESSO? .....	7
1. The EspressoPRO Coffee Center .....	7
2. Capresso Plus Service™ .....	7
3. Equipment .....	8
4. Please Do Not! .....	8
5. Preparing the Machine.....	8
6. Automatic Water Discharge Into Tray .....	8
7. Espresso Coffee .....	8
8. The Coffee Grind .....	9
9. Making Espresso .....	9
10. Cleaning Porta Filter and Sieve After Each Use .....	10
11. Choosing the Right Sieve .....	10
12. Using Pre-Packed Coffee Pods .....	10
13. Assembling the frothXpress System .....	10
14. Making Hot Frothed Milk .....	11
15. Regulating Temperature of Frothed Milk .....	11
16. Using the Flexible Hose with the frothXpress System.....	11
17. Making Cappuccino .....	11
18. Multiple Cappuccinos .....	11
19. Making Latte .....	12
20. Making Hot Chocolate with the frothXpress System.....	12
21. Dispensing Hot Water for Tea, Soup, Etc. ....	12
22. Cleaning .....	12
23. Cleaning Sieves and Inner Screen .....	12
24. Cleaning frothXpress System .....	12
25. Cleaning the Milk Container .....	13
26. Decalcifying (with Vinegar) .....	13
27. Decalcifying (with Durgol) .....	13
28. Troubleshooting .....	14
29. Frequently Asked Questions About...Coffee.....	15
Frequently Asked Questions About...The Espresso Machine.....	15
30. Limited Warranty.....	16
Capresso Customer Service .....	16
Product Registration (mail or fax) .....	17

## WHO IS CAPRESSO?

With more than 20 years experience in coffee equipment for consumers, I founded Capresso, Inc. in 1994.

My goal is to provide coffee makers and espresso/cappuccino machines for the customer who wants a superior product. Safety, reliability, performance, and convenience are the cornerstones of Capresso quality. Our products are available through selected retailers who can provide expert advice and will treat you as a valued customer. For a listing of Capresso dealers near you, please check out our website: [www.capresso.com](http://www.capresso.com).

I hope you will enjoy your new Capresso product and will recommend it to your friends.

*Michael Kramm, President*

## 1. THE ESPRESSOPRO COFFEE CENTER

Coffee experts consider brewing coffee under high pressure to be the ideal process to extract maximum flavor and aroma. The EspressoPRO produces perfect espresso – coffee with a thick, foamy layer on top called "crema."

The "crema" traps the fine aromatics and the light gaseous flavors that register on the palate. The "crema" keeps flavor locked in that would otherwise escape. The high pressure and short brewing time prevent the extraction of bitter oils and release less caffeine than other brewing methods. For this reason, many European restaurants serve "crema" coffee only.

Whether you are brewing a 1-ounce shot of espresso or a 12-ounce mug of coffee, your EspressoPRO produces the absolute freshest and most aromatic cup of "crema" coffee possible. Not only will your EspressoPRO make the perfect espresso, but within seconds the patented frothXpress system turns your espresso into a delicious cappuccino. Making hot frothed milk is not the only function of

the frothXpress. By pouring chocolate milk (made with chocolate syrup for best results) into the container you can create a cup of hot chocolate in seconds. For those non-chocolate lovers, stir a bit of honey into your frothed milk and a dash of cinnamon on top for a delicious warm beverage. The separate hot water supply allows you to make a cup of hot tea or instant soup in 30 seconds.

Your EspressoPRO is a true coffee center. Using the EspressoPRO reduces the time and effort normally involved in making espresso and cappuccino. The EspressoPRO comes equipped with two "regular" sieves as well as a "pod" sieve. Using coffee pods eliminates measuring coffee and facilitates clean-up.

## 2. CAPRESSO Plus Service™

- **HELP CALL 1-800-767-3554**  
(Monday – Friday 9AM to 9PM, Eastern Standard Time)
- **Email address:**  
[contact@capresso.com](mailto:contact@capresso.com)
- **Fax:** 201-767-9684
- **Website:** [www.capresso.com](http://www.capresso.com)

Our goal is to make sure that all of our customers are satisfied with their Capresso purchase. If you need assistance, call the above number. Feel free to call any time. If you are connected to our voicemail, PLEASE DO NOT HANG UP. Leave your name, telephone number, and please say, "model #112" so we know what machine you are calling in reference to. Let us know the best approximate time to call you back, or email or fax us at anytime. Our unique CAPRESSO Plus Service offers you the following within the first 12 months (within the USA Only):

- Free repair or replacement if your Capresso EspressoPro malfunctions, including shipping costs both ways and convenient UPS call tag pick-

up (UPS will come to your home to pick up your machine so you do not have to transport the machine to the UPS Station or post office).

### 3. EQUIPMENT

The EspressoPro comes with:

- Measuring scoop with tamper
- Porta filter
- Small sieve, one cup
- Large sieve, two cups
- Pod sieve
- Removable water container
- Milk container with lid
- Frothing attachments: 4 pieces
- Flexible hose
- Instruction manual
- Mail Order form

### 4. PLEASE DO NOT!

(Ignoring the following instructions may result in a VOID of your warranty protection)

- Do not use egg nog, heavy cream, half & half or any other heavy liquid with the frothXpress system.
- Do not use coffee pods in regular sieve; use in pod sieve only.
- Do not force the porta filter past the locked position.
- Do not attempt to steam/froth with out pre-warming first.
- Do not run the pump without water in the water tank.
- Do not try to run the appliance with a converter on other current or hertz (HZ) cycle.

### 5. PREPARING THE MACHINE:

- a. Clean all parts.
- b. Lift lid over water tank.
- c. Use handle to remove water tank and fill with cold, fresh water (fig. 2).
- d. Insert water tank securely into place.
- e. Turn the machine on (fig.1; 1a). The red indicator light in the On/Off switch lights up.
- f. When the orange thermostat light located over the selector knob illu-

minates, the machine has warmed up and is ready for use. (fig.1; 3)

- g. Place a sieve inside porta filter – **DO NOT ADD COFFEE!**
- h. Insert porta filter into filter holder by lining up arrow on thumb guard with INSERT line (fig. 3 ) Make sure the thumb guard is pulled back towards the handle.
- i. Lift up slightly and turn porta filter to the right until it CLICKS into locked position. (Do not force past the "LOCK" position!).
- j. Place a cup underneath porta filter. (fig. 11)
- k. Turn selector knob to right "brewing coffee" position (fig. 6 )
- l. Allow 3-4 ounces of water to run through machine. Turn the selector knob left back to the "O"-position. (fig. 5).

### 6. AUTOMATIC WATER DISCHARGE INTO TRAY

**ATTENTION:** The EspressoPro heats the water in a stainless steel lined Thermoblock system. Whenever you return the selector knob back to the "O"-position within a few seconds the machine will start to make noise. This noise indicates that the machine is discarding a small amount of warm "rest" water from the Thermoblock into the drip tray. (The machine will do this automatically.) Doing this eliminates any stale water build-up. The drip tray holds approximately 16 ounces of water and will overflow after about 20 cups of espresso.

**IMPORTANT:** To avoid water overflow we recommend pulling out and emptying the tray after every 10 cups of espresso. (fig. 19).

### 7. ESPRESSO COFFEE

An espresso is a highly concentrated coffee beverage (that is the reason, why most people add a bit of sugar to it!) Coffee bars use 7 to 8 grams of coffee per cup. The small sieve

(fig. 1; 10b) holds 7 grams, the large sieve (fig. 1; 10c) holds 15 grams of coffee. A cup or "shot" of espresso as it is commonly referred to, is no more than 1 to 1 1/2 ounces. Actual brewing time is 20 to 40 seconds. After brewing, the espresso should have a dense, foamy layer on top, called "CREMA." The crema indicates that the espresso is brewed correctly. It traps the aroma of the coffee underneath. The two most important factors for the right espresso flow and the crema production are

- **correct grind**
- **water temperature**

If the **grind is too fine**, no water or very little water will pass through the coffee. The result is no coffee or a bitter coffee without crema.

**CAUTION: Too much pressure!**

If no water or very little water passes through the machine, pressure will build up. Turn the selector switch back to the "O"-position and let sit for a minute. Then remove the porta filter very slowly, so that the excess pressure can escape. If you remove the porta filter too fast, hot ground coffee can jump out of the porta filter.

If the **grind is too coarse**, water will pass through too fast. The result is a weak coffee with little crema.

## 8. THE COFFEE GRIND

It is very important that your coffee is ground correctly. **Ask your local coffee store to grind your espresso about two to three settings coarser than usual.** The vast majorities of coffee specialty houses have properly maintained grinders and will be able to accommodate your request.

(Supermarket grinders may not always be maintained properly. Like home blade grinders, they may produce a lot of coffee dust. Coffee dust clogs the sieve, even if the coffee looks coarse.) If you have problems with the flow-

through of your coffee call:

**HELP CALL: 1-800-767-3554.**

If you prefer to grind your own beans ALWAYS use a burr grinder. Capresso offers a Burr Grinder (model #551) which will grind the coffee perfectly for your espresso pump machine.

## 9. MAKING ESPRESSO

- a. Before making the first cup of espresso we recommend that you pre-warm the machine, filter holder, and cup. Otherwise you may run the risk that your first cup of espresso is not as hot as it could be.
- b. Insert and lock the filter holder without a sieve and place an empty cup underneath spout. Turn selector knob to the cup position (fig. 6). Let two or three ounces of water run into the cup. Turn the selector knob back to the "O"-position to stop the flow of water (fig. 5).
- c. Remove the porta filter, insert the sieve and slightly overfill the sieve with coffee. Use the tamper on the end of the measuring scoop and tamp (pack) the coffee slightly down (fig. 4). Do not tamp too hard!
- d. Remove any coffee from the rim of the sieve (fig. 4a).
- e. Insert the porta filter and turn to the right until it is in the locked position (you will here a "click" as it locks) (fig. 3).
- f. Place a cup underneath the porta filter and turn the selector knob to the coffee cup position. Once the desired amount of coffee has been dispensed into your cup, turn selector knob back to the "O"-position.
- g. Remove the cup, add sugar to taste, and enjoy immediately. (Do not let an espresso sit for a long period of time after brewing, as its temperature will drop rapidly.)

**TIP:** When making an espresso as the

base for a cappuccino, we recommend frothing the milk first then brewing the espresso, (see chapter 17 and 18 "Making Cappuccino" / "Multiple Cappuccinos").

## 10. CLEANING PORTA FILTER AND SIEVE AFTER EACH USE

Before making the next espresso:

- a. Remove porta filter by turning to the left toward "INSERT"-position.
- b. Tilt thumb guard forward until top is over sieve and dump used coffee grinds into garbage (fig. 18 ). If you fail to place thumb guard over sieve it will fall into the garbage.
- c. Remove sieve from porta filter and rinse with warm water to remove any used coffee grinds. Hold sieve up to light to check if the small holes are clean.
- d. Rinse porta filter with warm water.

## 11. CHOOSING THE RIGHT SIEVE

Your EspressoPro comes with 3 different sieves. Two "regular" sieves and one "pod" sieve (see Chapter 12, "Using Pre-Packed Coffee Pods").

The small (one cup) sieve holds approximately 7 grams of coffee. This is normally enough to make one espresso measuring 1 1/2 ounces or up to a 6-ounce cup of "crema" coffee. The large (two cup) sieve holds approximately 15 grams of coffee and will produce an extra strong single espresso, two espressos, or up to a 12-ounce cup of "crema" coffee.

Coffee is always dispersed from both spouts on the porta filter. When making one cup, be sure your cup is centered underneath both spouts. (fig. 11). When making two espressos or two cups of coffee, be sure to place two cups underneath the porta filter (fig. 10).

## 12. USING PRE-PACKED COFFEE PODS

The special "pod" sieve allows you to use pre-packed coffee pods (fig. 9). (Please check with your local coffee stores or check our website: [www.cappresso.com](http://www.cappresso.com) under the EspressoPRO machine for more information.) **Please be sure to use the 45mm diameter pods with your EspressoPRO.** (These are most commonly available.) Other sizes do not work with the EspressoPRO.

**ATTENTION:** Some pods have a small tab that sticks out. Be sure to fold the tab under before inserting the pod into the pod sieve. (Failure to do so will result in water spilling out, etc.)

If you are using *illy* coffee pods, you must cut around the outer rim of the pod leaving about 3/8 of an inch around the coffee. **Before cutting** check to see which sides goes face down. Sides are marked. Be sure to place the sieve with the proper side down.

**\*\*Please be aware, brewing with coffee pods will not produce as much crema as brewing with ground coffee.\*\***

One coffee pod normally yields one serving. If you are making a double shot you must use two pods. **DO NOT PLACE 2 PODS IN SIEVE AT THE SAME TIME:** to brew a double shot, you must brew with one pod at a time, into the same cup.

## 13. ASSEMBLING THE frothXpress SYSTEM (fig. 1d).

**IMPORTANT** – in order to siphon milk through the frothXpress system all parts must be firmly connected. If the parts are loose, outside air may enter into the attachment making it impossible to siphon the milk.

- a. Attach connector into large hole of frothing sleeve. (parts V and W)
- b. Insert the knob into the joint and make certain it snaps into place firmly. (parts X and Y)

- c. Insert the joint firmly into the connector until you hear it "snap" into place ( parts Y and V).
- d. Attach the connector to the steam nozzle until the red seal of the steam nozzle is no longer visible. (parts V and U). The steam nozzle is already attached to the metal steam hose.
- e. Remove the lid of the milk container and fill it with milk.
- f. Replace the milk container lid and connect to the joint (parts Y and Z).
- g. Make certain that the knob is parallel to the joint (fig. 13) If the knob is perpendicular to the joint, the flow of milk will be blocked (fig. 14).

#### 14. MAKING HOT FROTHED MILK

The frothXpress system allows you to heat and froth milk directly into your cup.

- a. Place a cup underneath the frothing sleeve (fig. 12).
- b. Press selector switch on top of machine to the steam position (fig. 1; 1b).
- c. Turn selector knob to the pre-heating position (fig. 7).
- d. When the orange thermostat light illuminates, the system is ready to froth. Turn selector knob to steam position (fig. 8).
- e. The frothXpress system will automatically dispense hot frothed milk into your cup. When you have enough frothed milk, turn the knob back to the "O"-position (fig. 5).

**IMPORTANT:** Clean frothXpress system immediately after use (see chapter 24)!

#### 15. REGULATING TEMPERATURE OF FROTHED MILK

Maximum milk flow, with maximum froth, is achieved when the knob is parallel to the joint (fig. 13). Turning the knob approximately 20 to 40 degrees (fig.15) will slow down the

flow of milk, increasing the milk temperature and decreasing the amount of froth. The temperature of the milk will vary between 120° F and 160° F depending on the position of the knob. **ATTENTION:** If you turn the knob too much the milk will splatter. If the knob is perpendicular to the joint (fig. 14), the flow of milk will be blocked. Only hot steam will pass through frothXpress system. For best results, be careful not to turn the knob too far in either direction.

#### 16. USING THE FLEXIBLE HOSE WITH THE frothXpress SYSTEM

Instead of using the milk container provided, you may chose to froth milk directly from your milk carton. The flexible hose provided allows you to do this easily and without mess. Simply attach the hose to the joint and insert the end of the hose directly into a small milk carton (fig. 16). **IMPORTANT:** The hose must point downward to function properly. This means the milk carton must not be taller than the frothXpress system. You may cut the hose to fit properly if necessary.

#### 17. MAKING CAPPUCCINO

Italian Cappuccino is the combination of one or two espressos with 3 to 6 ounces of hot frothed milk. With the EspressoPRO you can either prepare the coffee first and then froth the milk, or froth the milk first and then prepare the espresso directly into the cup which contains the frothed milk. The advantage of the latter is that you do not have to pour the espresso into the cappuccino cups.

#### 18. MULTIPLE CAPPUCCINOS

When making multiple cups of cappuccino we recommend frothing the milk directly into the number of cups you intend to prepare. Place cups

with the hot frothed milk already inside under the porta filter (two at a time) and brew your coffee directly into the frothed milk. This is a fast, easy way to prepare multiple cups of cappuccino.

## 19. MAKING LATTE

Latte is similar to Cappuccino. The difference is that, in general, the milk added has very little or no froth on top. In order to reduce the amount of froth using the frothXpress system you must turn the knob slightly to the left or right (see Chapter 15 - "Regulating Temperature of Frothed Milk"). If you have too much froth, simply discard it and just use the hot steamed milk.

## 20. MAKING HOT CHOCOLATE WITH THE frothXpress SYSTEM

- Fill the milk container with cold chocolate milk. For best results, use chocolate syrup as opposed to powdered mix. Be sure syrup is completely dissolved before frothing.
- Follow instructions in Chapter 14 - "Making Hot Frothed Milk."

## 21. DISPENSING HOT WATER FOR TEA, SOUP, ETC.

You may dispense hot water (approximately 160° F - 170° F) through the frothing sleeve. Perfect for making tea, instant soup, etc.

To dispense hot water:

- a. Press the selector switch on top of the machine to the hot water position (fig. 1; 1b).
- b. Remove the joint and the knob from the frothXpress system.
- c. Place a cup or a glass underneath the frothing sleeve (fig. 17).
- d. Turn the selector knob to the steam position (fig. 8).
- e. The machine will immediately dispense a fast stream of hot water.

- f. To stop the flow of water, turn the selector knob back to the "O"-position (fig. 5).

## 22. CLEANING

**CAUTION:** Let the machine cool down before cleaning. For your safety we recommend unplugging the machine before cleaning. **Never** immerse the appliance in water or any other liquid. **Never** clean appliance under running water. **Never** use scouring agents. To clean:

- a. Wipe with a soft, damp cloth.
- b. Lift and pull out the drip tray (fig. 19).
- c. Clean the grid, drip tray, water tank, and filter holder under running water and dry thoroughly. Do not put drip tray in the dishwasher.
- d. Rinse porta filter and sieves with warm, soapy water.

## 23. CLEANING SIEVES AND INNER SCREEN

- Clean the sieves with warm water, making sure that the mesh is free of coffee oils. Hold sieve up to light to check if the small holes are clean. Soak in a mild detergent and scrub lightly if necessary.
- The inner screen should also be cleaned. Use a coin to unscrew inner screen (fig. 20). Wipe inside clean and replace screen. Make sure to screw in securely.

## 24. CLEANING frothXpress SYSTEM (SHOULD BE DONE IMMEDIATELY AFTER USE!)

If you do not clean the frothXpress System immediately after each use, hardened milk will undoubtedly deposit in the knob, joint, frothing sleeve, and connector. Hardened milk deposits are very difficult to remove. Therefore, we highly recommend cleaning following each use.

To clean:

- a. Disconnect the milk container from the joint (fig. 1d; Y and Z).

- b. Remove the four parts – knob, joint, connector, and frothing sleeve.
  - c. Rinse all parts under warm running water. You may also soak all parts in a cup of hot water after rinsing.
  - d. Place a large cup underneath the steam nozzle and turn the steam knob to the steam position (fig. 8). Let some steam run through for a few seconds, then turn the selector knob back to the "O"-position (fig. 5).
  - e. Re-assemble system (see chapter 13).
- c. Fill the water container with three cups (24 oz.) of water and 1 1/2 cups (12 oz.) of white household vinegar.
  - d. TURN MACHINE ON and pump about 4 oz. of water through the portafilter. Stop and let machine rest for approx. 2 minutes. Repeat 4 times.
  - e. Now decalcify the steam tube. Place a container underneath the steam tube. Press selector switch on top of the machine to the hot water position and turn the selector knob to the steam position (fig. 8). Let about 4 oz. of water run through the steam tube. Then stop and let machine rest for approx. 2 minutes. Repeat three or four times.

## 25. CLEANING THE MILK CONTAINER

- Remove the lid of the milk container. (The milk container is dishwasher safe-**upper rack only**.)
- Hold the lid under warm running water and allow some water to run through the straw. For a more thorough cleaning take the lid assembly apart (lid, seal, straw) and rinse with water and/or soak in hot water.

**IMPORTANT:** When replacing the three parts, first insert the seal into the receptacle on the underside of the lid, then push the straw inside the seal to ensure a tight fit (fig. 21).

## 26. DECALCIFYING (With Vinegar)

For prolonged use of your Espresso-PRO it is necessary to decalcify the machine regularly. Calcium (limestone) found in drinking water will leave deposits in the machine that may cause clogging.

We highly recommend that you decalcify your machine at least twice a year or after about 400 uses (= 400 espressos or 200 espressos plus 200 frothing cycles).

### **Decalcifying Instructions:** MACHINE IS OFF

- a. Before you start decalcifying remove the inner screen (fig. 20) and unscrew the steam nozzle (fig. 1d; U).
- b. Insert the porta filter without a sieve and place a large container

underneath the porta filter.

- f. Clean water tank thoroughly, fill with fresh water and pump half of the water through the porta filter and half through the steam tube to eliminate any vinegar smell or taste.
- g. Replace the inner screen and the steam nozzle.

**\*\*If using a commercial decalcifying agent please make sure it is suitable for drip coffee makers and follow the manufacturer's instructions.\*\***

## 27. DECALCIFYING WITH DURGOL

Capresso and many European companies recommend "Durgol" – a liquid decalcifying agent that removes calcium deposits up to 20 times faster than vinegar.

Prepare the machine as described in Chapter 26 – steps (a) and (b). Pour one cup of water, then one cup of Durgol into the water tank (total of 16 oz.).

- a. Turn the machine on and pump about 4 oz. of water through the porta filter. Stop and let machine rest for approximately 2 minutes. Repeat one more time.

**b.** Now decalcify the steam tube. Place a container underneath the steam tube. Press selector switch on top of the machine to the hot water position and turn the selector knob to the steam position (fig. 8). Let about 4 oz. of water run through the steam tube. Then stop and let machine rest for approx. 2 minutes. Repeat one more time.

**c.** Clean water tank thoroughly by filling half way with fresh water. Pump half of the water through the porta filter and half through the steam tube to eliminate Durgol residue.

**d.** Replace the inner screen and the steam nozzle.

## **28. TROUBLESHOOTING**

### **a. My coffee is not hot enough**

- See chapter 9 (a).
- Drink your coffee immediately after brewing.  
For cappuccino or latte: make sure to increase the milk temperature (chapter 15).

### **b. No coffee or very little coffee comes through the porta filter**

- Make sure the water tank has water in it and that it is inserted properly.
- Make sure the selector knob points to the coffee cup position.
- The coffee may be ground too fine, use coarser coffee (chapter 7).
- The small holes of the sieve may be blocked, clean sieves (chapter 23).
- The inner screen may be blocked (chapter 23).

### **c. Coffee runs very fast into the cups with very little crema**

- Your coffee may be ground too coarse. Use a finer grind.
- Make sure the sieve is always filled completely with coffee.

### **d. Coffee does not flow into both cups at exactly the same rate**

\*Normal distribution is at least 40/60\*

- Clean the porta filter and the sieve (chapters 22, 23).
- Make sure the sieve is filled completely and evenly.
- Coffee may be ground unevenly allowing water to pass through it faster on one side than through the other.

### **e. I am not getting any crema or not enough crema**

- Your coffee is not ground correctly. If the flow of coffee is too slow, use a coarser grind, if the flow of coffee is too fast, use a finer grind.
- When using pre-packed pods you normally get less crema than when using ground coffee. Make sure to use the pod sieve with pods.

### **f. There is some coffee residue in the bottom of my cup**

- This is normal. With pressure brewed coffee you will always have some fine coffee powder in the bottom of your cup.
- If this bothers you, try pre-packed coffee pods (chapter 12). The paper cover acts like a filter.

### **g. Water and coffee run down on the side of the porta filter**

- Wipe the inner screen with a wet paper towel.
- Make sure that the rim of the sieve and the porta filter are free of coffee grounds before inserting into the machine.
- When using pre-packed coffee pods: trim the sides of the paper cover so that the paper does not extend outside of the sieve.

### **h. When using the frother I am not getting sufficient froth**

- If you had sufficient froth before then some or all of the frothXpress parts are clogged or not put together

parts are clogged or not put together correctly. See chapters 13 and 24 to correct.

- The best froth is made with low or no fat milk. Using whole milk may result in a "weaker" froth.

**i. The frothed milk is not hot enough**

- See Chapter 15 on how to increase the milk temperature.

**29. FREQUENTLY ASKED QUESTIONS about**

**...Coffee**

**a. Where and how should I store my coffee?**

- Ideally coffee beans should be ground just prior to brewing.
- **Whole coffee beans** stay fresh for approximately two weeks. Store in a dark, airtight container. Do not store in freezer or refrigerator.
- **Ground coffee** loses flavor from the moment it is ground; be sure to store in a dark, airtight container. Do not store in freezer or refrigerator. Ground coffee has a very high oxidation rate and may take on flavors and aromas from other foods.

**b. Should I use dark or light coffee beans?**

- In Italy the beans for espresso are roasted to a light to medium color (no oils on the outside). That gives the espresso a rich, strong taste without bitterness.
- In the USA most specialty roasters roast the beans for espresso to a dark to very dark color with more or less oils on the outside. This gives the espresso a more intense and sometimes bitter taste. Many people prefer that type roast when drinking cappuccino or latte since the milk eliminates some or all of the bitterness.

- Try both kinds and see what you like best.

**c. Can I use the same coffee for espresso and "crema coffee"?**

- Yes, when you brew longer ("Crema coffee") the taste will be less intense. You can also brew an espresso and then add hot water. This is called a Coffee Americano.

**d. Which coffee is better for cappuccino, "French Roast" or "Italian Roast"?**

- This is totally up to you. Try it out. Normally the "French Roast" is roasted slightly longer and at a slightly higher temperature giving it a stronger and more bitter taste.

**e. Can I use coffee that is not labeled "espresso"?**

- Yes you can. Make sure it is "Arabica" coffee or a blend with "Arabica" beans. "Robusta" beans are normally used for drip coffee and have less aroma.

**...the Espresso Machine**

**f. Can I fill other liquids into the water tank, such as milk or sweetened water?**

- No, you will destroy the pump and the Thermoblock system.

**g. Can I use distilled water?**

- Yes, although distilled water is free of important minerals and may give your coffee a different taste. You can also use "reverse osmosis" water.

**h. Can I use the machine overseas with a converter?**

- We do not recommend it. The machine is designed for 120 volts/60Hz. Other voltage and Hz cycles might damage the machine. Also, Capresso's warranty covers the United States only (see chapter 30).

**i. Can I send the machine to another country with 120-volt/60Hz configuration?**

- Yes, but in case the machine needs service the transportation costs will not be covered by Capresso. Our warranty is limited to the United States (see chapter 30).

**j. I have a small grinder with a blade. Can I use this grinder grind my coffee for this machine?**

- Try it. In most cases blade grinders will create too much "coffee dust". It will clog the fine holes in the sieve. The water will not be able to pass through the coffee. A burr grinder gives you a more consistent grind (chapter 8).

**k. How long can I leave the machine on?**

- The EspressoPRO is in standby when not in use. You can leave it on all day long.

**30. LIMITED WARRANTY**

The warranty covers your CAPRESSO EspressoPRO machine, model #112. This warranty is in effect for one year from the date of initial consumer purchase, and is limited to the United States of America. This warranty covers all defects in materials or workmanship (parts and labor) including UPS ground transportation both ways, if necessary.

The warranty **DOES NOT** cover:

- Any machine not distributed by CAPRESSO within the United States.
- Any machine not purchased from and Authorized CAPRESSO Dealer.
- Commercial use of the machine.
- Damage caused by accident, abuse, negligence, misuse, improper operation or failure to follow instructions contained in this manual.
- Any service or alteration performed by an unauthorized person, company, or association.

**Other limitations and exclusions:**

Any implied warranties including fitness for use and merchantability are limited in duration to the period of the express warranty set forth above and no person is authorized to assume for CAPRESSO any other liability in connection with the sale of the machine.

CAPRESSO expressly disclaims liability for incidental and consequential damages caused by the machine. The term "incidental damages" refers to the loss of the original purchasers time, loss of the use of the machine or other costs relating to the care and custody of the machine. The term "consequential damages" refers to the cost of the repairing or replacing other property which is damaged when this machine does not work properly. The remedies provided under this warranty are exclusive and in lieu of all others.

This warranty gives you specific legal rights. Rights may vary from state to state.

**CAPRESSO CUSTOMER SERVICE**

81 Ruckman Road  
Closter, New Jersey 07624

**HELP CALL:** 1-800-767-3554

**Fax:** 201-767-9684

**Email address:**

contact@capresso.com

**Website:** www.capresso.com

# CAPRESSO EspressoPRO #112

## Product Registration

Please complete this registration after you have used your machine for a few days. Your information will help us to better serve you in the future.

Thank you for buying from CAPRESSO.

Please print clearly

Last Name \_\_\_\_\_

First Name \_\_\_\_\_  Male  Female

Address \_\_\_\_\_

City \_\_\_\_\_ State \_\_\_\_\_ Zip \_\_\_\_\_

Your Email Address \_\_\_\_\_

Purchased from:

- Specialty store  Mail order  Department store  Internet company  
 Received as gift

Name of retailer \_\_\_\_\_

Purchase Date \_\_\_\_\_ Purchase Price \$ \_\_\_\_\_

### Reasons for buying this product:

- Concept/Features  Saw it on TV  Print advertising  
 Retailer recommendation  Recommended by a friend

### Do you use an espresso/cappuccino machine regularly?:

- Yes  No

### I drink (mark all that apply):

- Regular coffee  Cappuccino  Latte  Espresso  Hot Chocolate

### What other espresso machine did you use before?:

- None  Krups  Salton  Gaggia  DeLonghi  
 Other: \_\_\_\_\_

Would you like more information about our products?:  Yes  No

### Your annual household income:

- Under \$50,000  \$50,000 – \$100,000  \$100,000 – \$250,000  \$250,000 +

Your age group:  Under 25  25–40  41–45  46–55  56–65  65 +

### Any suggestions on how we can improve this product?

\_\_\_\_\_  
\_\_\_\_\_

Would you recommend this product to your friends?:  Yes  No

Mail to CAPRESSO Inc., P.O. Box 775, CLOSTER, NJ 07624  
or **FAX to: (201) 767-9684.**

*Capresso*

81 Ruckman Road, Closter, NJ 07624  
201-767-3999 • Fax: 201-767-9684  
Email: [contact@capresso.com](mailto:contact@capresso.com)  
Website: [www.capresso.com](http://www.capresso.com)