

# *Kapresso* **Steam** PRO

**Espresso &  
Cappuccino  
Machine**

Model #304

- Instructions
- Warranty



# IMPORTANT SAFEGUARDS

When using electrical appliances, basic safety precautions should always be followed, including the following:

- Read all instructions.
- Do not touch hot surfaces. Use handles or knobs.
- To protect against fire, electric shock and personal injury do not immerse cord, plugs, or appliance in water or other liquid.
- Close supervision is necessary when any appliance is used by or near children.
- Unplug from outlet when not in use and before cleaning. Allow to cool before putting on or taking off parts, and before cleaning the appliance.
- Do not operate any appliance with a damaged cord or plug or after the appliance malfunctions, or has been damaged in any manner. Return appliance to the nearest authorized service facility for examination, repair or adjustment.
- The use of accessory attachments not recommended by the appliance manufacturer may result in fire, electric shock or personal injury.
- Do not use outdoors.
- Do not let cord hang over edge of table or counter, or touch hot surfaces.
- Do not place on or near a hot gas or electric burner, or in a heated oven.
- Always attach plug to appliance first, then plug cord into the wall outlet. To disconnect, turn the power switch off, then remove plug from wall outlet.
- Do not use appliance for other than intended use.
- Use extreme caution when disposing hot steam.
- Appliances with Glass Containers.
  - A. The container is designed for use with this appliance. It must never be used on a range top.
  - B. Do not set a hot container on a wet or cold surface.
  - C. Do not use a cracked container or a container having a loose or weakened handle.
  - D. Do not clean container with cleansers, steel wool pads, or other abrasive material.

## SAVE THESE INSTRUCTIONS

# SPECIAL CORD SET INSTRUCTIONS

Regarding your Cord Set:

- A. A short power-supply cord (or detachable power-supply cord) is to be provided to reduce risks resulting from becoming entangled in or tripping over a longer cord.
- B. Longer detachable power-supply cords or extension cords are available and may be used if care is exercised in their use.
- C. If a long detachable power-supply cord or extension cord is used, (1) the marked electrical rating of the detachable power-supply cord or extension cord should be at least as great as the electrical rating of the appliance, (2) if the appliance is of the grounded type, the extension cord should be a grounding type 3-wire cord, and (3) the longer cord should be arranged so that it will not drape over the counter top or table top where it can be pulled on by children or tripped over.
- D. This appliance has a polarized plug (one blade is wider than the other). As a safety feature, this plug will fit in a polarized outlet only one way. If the plug does not fit fully in the outlet, reverse the plug. If it still does not fit, contact a qualified electrician. Do not attempt to defeat this safety feature.

## CAUTION:

This appliance is for household use. Any servicing other than cleaning and user maintenance should be performed by an authorized service representative.

- Do not immerse base in water or try to disassemble.
- To reduce the risk of fire or electric shock, do not remove the base. No user serviceable parts inside. Repair should be done by authorized service personnel only.
- Check voltage to be sure that the voltage indicated on the name plate agrees with your voltage.
- Never use warm or hot water to fill the water container! Use cold water only!
- Keep your hands and the cord away from hot parts of the appliance during operation.
- Never clean with scouring powders or hard implements.

**Fig. 1**

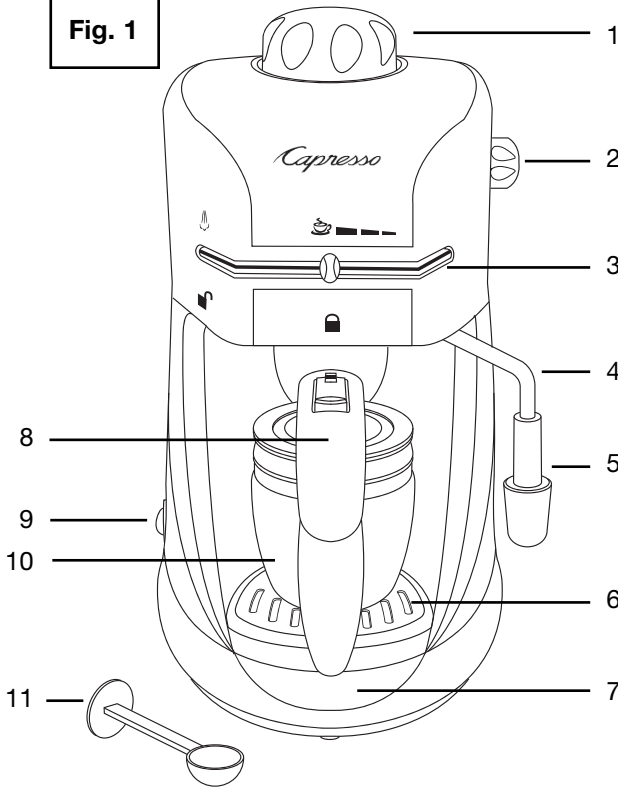

1. Boiler cap
2. Steam knob (fig. 9)
3. Coffee/steam selector
4. Steam pipe
5. Nozzle
6. Tray cover
7. Drip tray
8. Filter holder in "locked" position
9. Power switch
10. Glass carafe with lid
11. Scoop

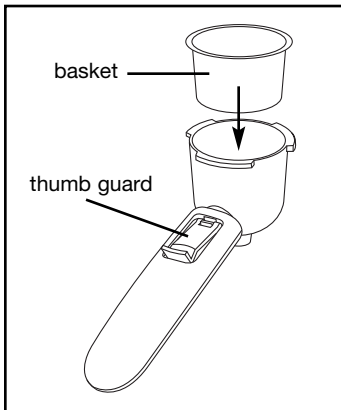

**Fig. 2**

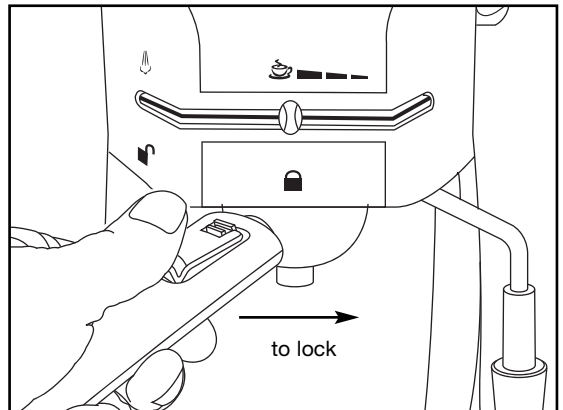

**Fig. 3**

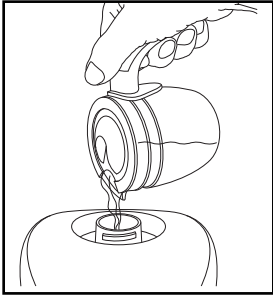

**Fig. 4**

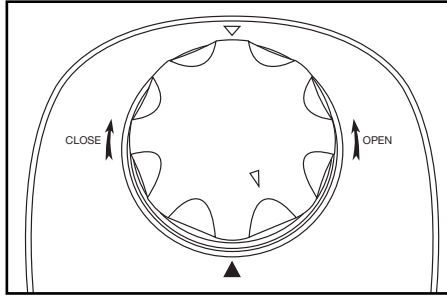

**Fig. 5**

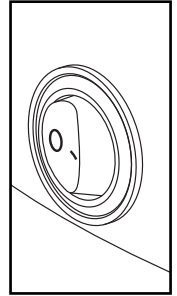

**Fig. 6**

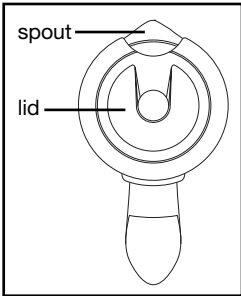

**Fig. 7**

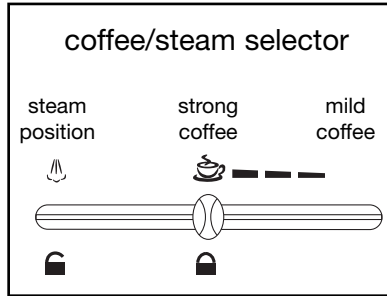

**Fig. 8**

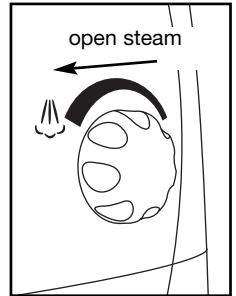

**Fig. 9**

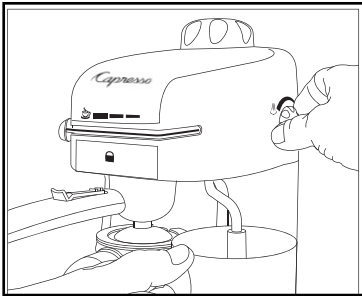

**Fig. 10**

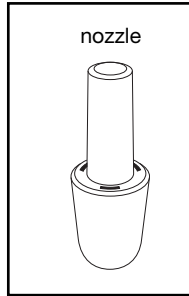

**Fig. 11**

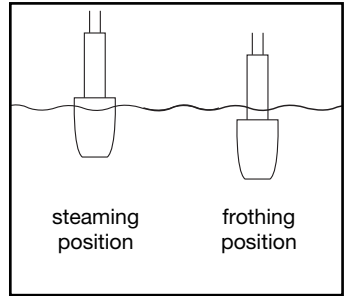

**Fig. 12**

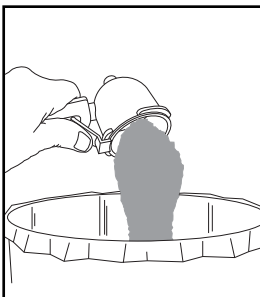

**Fig. 13**

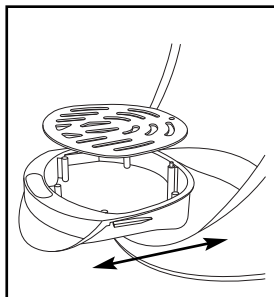

**Fig. 14**

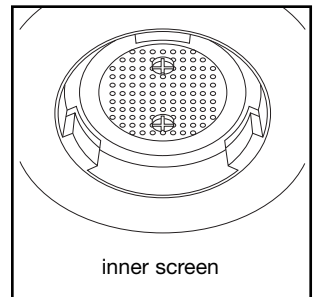

**Fig. 15**

IMPORTANT SAFEGUARDS.....	2
ILLUSTRATIONS.....	4
1. WELCOME AND THANK YOU .....	6
2. HOW TO REACH JURA-CAPRESSO.....	6
3. DE-PRESSURIZING.....	6
4. BEFORE INITIAL USE.....	7
5. SAFETY BOILER CAP .....	7
6. HELPFUL HINTS .....	7
7. PREPARING ESPRESSO.....	8
8. PREPARING CAPPUCCINO AND LATTE.....	9
9. HOW TO STEAM/FROTH EFFECTIVELY.....	10
10. MAKING HOT WATER FOR TEA OR OTHER HOT BEVERAGES.....	10
11. CLEANING.....	10
12. DECALCIFYING.....	10
LIMITED WARRANTY .....	11

**1. WELCOME AND THANK YOU**

Thank you for choosing the Capresso Steam PRO Espresso & Cappuccino Machine. It is the perfect starter machine for espressos, cappuccinos and lattes. With a bit of practice you will be able to produce two to four cappuccinos or lattes at a time. Please read all of the instructions in this booklet before operating your new machine. Understanding and complying with these instructions is essential to ensure that the machine is utilized without risk and to ensure safety during operation and maintenance.

**2. HOW TO REACH JURA-CAPRESSO**

Should you require further information or if particular problems occur that are not covered in this manual, please

- CALL our toll free HELP LINE: 1-800-767-3554 Monday -Thursday 8AM to 9PM, Friday 8AM to 8PM and Saturday 9AM to 5PM Eastern Standard Time. Feel free to call at any time. If you are connected to our voicemail, PLEASE DO NOT HANG UP. Leave your name, telephone number and we will return your call. Please also leave the model number of your Capresso product, in this case it is #304.
- FAX us at 1-201-767-9684
- E-MAIL us at [contact@jura-capresso.com](mailto:contact@jura-capresso.com)
- VISIT our website at [www.capresso.com](http://www.capresso.com)
- WRITE to Jura Capresso, Inc., Customer Service, P.O. Box 775, Closter, NJ 07624

**3. DE-PRESSURIZING**

**CAUTION!** Never open the boiler cap and never remove the filter holder as long as there is pressure in the boiler container. In order to check if the machine is still under pressure follow these steps:

1. The machine is on, the filter holder is inserted and the boiler cap is closed.
2. Place an empty cup under the frother nozzle (fig. 10).
3. Move the coffee/steam selector to the steam symbol (fig. 8).
4. Open the steam knob (fig. 9). Wait until all steam is released.

5. Turn the power switch off (fig. 6).
  6. Open and remove the boiler cap (see chapter 5)
  7. It is now safe to remove the filter holder.
  8. Move the coffee/steam selector to the cup symbol (fig. 8).
- Caution:** Never try to remove the filter holder with the carafe in place. Pressure could force the filter holder down, smashing the carafe and causing severe injuries. Always remove the carafe first.
- Caution:** Never leave machine unattended when it is turned on (red light in the power switch is illuminated). Always turn the machine off when finished.

#### 4. BEFORE INITIAL USE

Carefully unpack your machine and remove all packing materials. Wipe the machine with a damp cloth. Clean the filter holder, the basket and the carafe with water and wipe dry. The filter holder, the basket, the glass carafe and lid are dishwasher safe (upper rack, away from any heating element).

**Caution:** Do not immerse the machine in water or any other liquid. The boiler cap is not dishwasher safe. Make yourself familiar with the various parts: insert the basket into the filter holder (fig. 2) and insert the filter holder into the machine (fig. 3). Open and close the boiler cap. Make sure the power cord is guided in the back slot so the machine sits firmly and flat on an even surface.

#### 5. SAFETY BOILER CAP

**To open the boiler cap:** turn the cap a quarter turn counter clockwise. Slightly lift the cap and turn another quarter turn counter clockwise and lift the cap.

**To close the boiler cap:** Place the cap onto the boiler neck and turn clockwise until cap sinks into the groove. Continue turning the cap until firmly locked.

#### 6. HELPFUL HINTS

- **Espresso Drink:** An espresso is a far richer drink with a more intense taste than regular brewed drip coffee. An espresso is normally 1 1/2 to 2 oz. of strong coffee. Espresso should be served immediately after brewing. If the espresso is too strong, you can add hot water. Add sugar to taste.
- Preparing espresso is different than preparing regular drip coffee. The machine works under pressure, bringing the water to a boil and then forcing it through the ground coffee in a short period of time.
- **Important:** The water in the boiler of the machine will get hotter during the brewing process. Towards the end of the brewing process the water will be so hot that it would burn your espresso. Therefore you never want to process all the water through the coffee as this will result in a burnt taste.
- **Which Coffee?** Any coffee labeled "espresso" is suitable for your machine. Any coffee with at least 80% Arabica beans is ideal for espresso preparation. Check with your local coffee store.
- **Which Grind?** Steam boiler espresso machines, do not require a fine espresso grind. For maximum flavor and aroma we recommend a medium espresso grind or a fine drip grind. If you grind your own coffee we recommend using a burr or disk/burr grinder. Small blade grinders can create "coffee dust". Coffee dust can dramatically slow down the water flow during brewing resulting in bitter and overheated coffee taste.
- **Cappuccino:** 1 1/2 to 2 oz. of espresso coffee with 3 to 4 oz. of steamed and frothed milk on top. Sprinkle chocolate shavings or cinnamon on top of

the milk froth. For a stronger taste increase the amount of coffee. For a milder taste increase the amount of milk.

- **Latte:** 1 1/2 to 2 oz. of espresso coffee with 3 to 4 oz. of steamed milk (very little or no milk froth).
- **Frothing:** Foamy layer of milk froth on top of hot milk.
- **Which kind of milk?** Skim milk and 1% milk will produce more milk froth than 2% or regular milk.
- **Markings on Glass Carafe:** The markings on the glass carafe help you in the preparation of brewing and frothing.

**Upper rim of metal band:** Maximum capacity of boiler (approx. 10 oz.). For best results always fill the boiler with 10 oz. of fresh cold water.

**4 cup marking:** Maximum amount of espresso you should brew (approx. 8 oz.). If you brew more than 8 oz. the coffee will taste burnt. Depending on the coffee roast you might even want to brew a little less to avoid a bitter aroma.

**2 cup marking:** (approx. 4 oz.), guide line for a double shot of espresso.

**Bottom line marking:** Once the coffee has reached this level there is enough pressure in the boiler for steaming and frothing.

## 7. PREPARING ESPRESSO

**Caution:** Do not leave the machine alone during brewing.

Keep children away during brewing.

1. Make sure the machine is plugged in and turned off. The glass carafe is removed from the drip tray. **Important:** The steam knob (fig. 9) must be in the closed position. The coffee/steam selector points to the cup symbol in front of the machine (stronger coffee). Moving the coffee/steam selector to the right, accelerates brewing and decreases coffee strength.
2. Fill the basket with ground coffee, using the measuring scoop (fig.1). The basket is marked on the inside indicating "2 cups" and "4 cups". Never overfill the basket. Clear any excess coffee from the rim of the filter holder. **Important:** it is not necessary to tamp (press down) the coffee.
3. Insert the basket into the filter holder (fig. 2), then insert the filter holder into the machine (fig. 3).
4. Turn filter holder to the right until it reaches the "locked" position (fig.1,8).
5. Fill the glass carafe to the upper rim of the metal band (approx. 10 oz.) with fresh, cold water.
6. Unscrew the boiler cap (see chapter 5). Using the glass carafe, fill the boiler with water (fig. 4) and close the boiler cap securely (see chapter 5).
7. Place the carafe lid on the carafe so that the opening on the lid points towards the pouring spout of the carafe (fig. 7). Place the carafe on the drip tray as shown in fig. 1.
8. Turn the power switch on (fig. 6). The power switch illuminates and the machine starts heating the water.
9. After approx. 2 1/2 to 3 minutes hot water will start forcing its way through the filter holder into the carafe.

When you have enough espresso in the glass carafe turn the power switch off and turn the coffee/steam selector to the steam symbol on the left to stop the flow. Remove the carafe and serve. Add a bit of sugar and enjoy.

**Tip:** To avoid a "burnt taste" never process all the water through the coffee. Once the brewing noise increases and steam develops, stop the brewing.



10. **Important:** Do not open the boiler cap. Do not remove the filter holder. First depressurize the machine. See chapter 3.
11. After de-pressurizing remove the filter holder by turning it to the left to the "open lock" symbol. Then push the thumb-guard of filter holder over the hot rim of the basket. Dump the used coffee (fig. 13) and rinse the basket and the filter holder under running water. Return the coffee/steam selector to the cup symbol.

## 8. PREPARING CAPPUCCINO and LATTE

Cappuccino and Latte are the most popular espresso-based coffee drinks. It is important that you follow the steps below precisely, otherwise you may not have enough steam pressure to froth and steam milk properly.

1. Fill a pitcher with 6 to 8 oz. of cold milk and set aside. The pitcher should have at least a 12 oz. capacity. Make sure the frother points outwards and the black frother nozzle is in place.
2. Follow steps 1 through 8 in chapter PREPARING ESPRESSO.
3. After approx. 2 1/2 to 3 minutes hot water will start forcing its way through the filter holder into the carafe. When the espresso coffee has reached the bottom marking of the glass carafe, slide the coffee/steam selector to the steam symbol.
4. Immerse the black frother nozzle into the pitcher with the milk so that the lower part of the nozzle is completely covered in milk (fig. 12, frothing position). The tip of the nozzle should not hit the bottom of the pitcher.
5. With the right hand slowly turn the steam knob towards the steam symbol (fig. 9 &10). Steam will push out into the pitcher. The more you open the steam knob the more steam will be released. If the steam is too powerful, turn the steam knob back to reduce the steam output. This procedure might take a little practice (see below). Once you have injected enough steam into your milk, turn the steam knob back to stop the steam output completely. Set the pitcher with the frothed milk aside. **Caution:** The steam pipe is hot
6. Move the coffee/steam selector back to the cup symbol. Coffee will continue brewing into the carafe.
7. Stand by and turn off the power switch when you have enough espresso in the glass carafe. Turn the coffee/steam selector to the steam symbol on the left to stop the flow.
8. Remove the carafe and pour the espresso into your latte/cappuccino cups. Add sugar to taste. Add the steamed milk and ladle some of the froth on top. Enjoy.
9. **Important:** Follow steps 10 and 11 in chapter 7, "Preparing Espresso".

## 9. HOW TO STEAM / FROTH EFFECTIVELY.

The tip of the black frothing nozzle has three visible slots on top (fig. 11). If the three slots are immersed into the milk, the steaming action will create froth (for cappuccino). If the three slots are above the milk level, the frother will inject steam into the milk without or very little froth (for latte) (fig. 12).

**Recommendation:** Always start with the three slots above the milk level. This way the steam first starts heating/steaming the milk. Then immerse the nozzle further into the milk to create froth. Set the steamed/frothed milk aside so that the froth can settle.

## 10. MAKING HOT WATER FOR TEA or OTHER HOT BEVERAGES

You can use the machine to make approx. 8 oz. of hot tea or to prepare instant soup. Fill the boiler with up to 8 oz. of water. Insert the filter holder into the machine without the filter basket and turn the filter holder to the right until it is locked in place. Close the boiler cap. Make sure the coffee/steam selector is turned to the cup symbol.

**For tea:** place one tea bag in the glass carafe.

**Hot instant soup:** pour the dry ingredients of the instant soup into the glass carafe. Place the glass carafe with its lid underneath the filter holder.

Turn the machine on and let all the water process through the filter holder into the carafe. When no more water comes out of the filter, turn the machine off, remove the carafe and serve.

## 11. CLEANING

- Always unplug the machine before cleaning.
- Never use scouring agents.
- Wait until machine has cooled down.
- Never immerse the machine in water or any other liquid. Never hold the machine under running water. To clean, simply wipe off with a soft, damp cloth.
- Clean the filter basket, the filter holder, and the glass carafe in a hot water/mild soap solution. For your convenience, the filter holder, filter basket, and glass carafe can be put in the dishwasher's upper level, away from any heating element. Make sure the holes in the filter basket are free of old coffee deposits.
- Remove the tray cover and drip tray and clean with hot water/mild soap solution. Replace the tray cover and drip tray and make sure the drip tray is locked in place.
- Wipe the inner screen with a wet cloth (fig. 15). The screen is located above the filter holder area.

## CLEANING THE FROTHER NOZZLE

Wait until the machine has cooled down. The metal frother pipe may still be hot. Pull the frother nozzle off and thoroughly rinse under warm water. Make sure the nozzle is free of any milk deposits. Replace the frother nozzle. Make sure it is firmly pushed up the frother tube.

## 12. DECALCIFYING

We recommend decalcifying the machine every 3 months or more frequently if you use hard water with this product. Remove the nozzle from the steam pipe. Fill the glass carafe with 2 oz. of white vinegar and 6 oz. of cold water and pour into the boiler. Close the boiler cap. Insert the filter holder with the basket into the machine and lock the filter holder. Place the glass carafe without the lid under the filter holder on the drip tray. Place an empty cup under the steam pipe. Make sure the coffee/steam selector points to the cup symbol and the steam knob is closed. Turn the machine on and let the solution pass through the filter holder into the machine. With the carafe about  $\frac{3}{4}$ -filled with solution (6 oz.), slide the coffee/steam selector to the steam symbol. Slowly turn the steam knob to pass the solution through the steam pipe and into the empty cup. Once steaming has stopped, close the steam knob, slide the coffee/steam selector to the cup symbol and turn the machine off. Remove and empty the carafe and cup. Allow machine to cool for about five minutes and open and remove the boiler cap. Repeat above process once or twice with only

water to remove any vinegar taste from the machine. (Please see Caution statements in chapter 3, Depressurizing.)

## LIMITED WARRANTY

This warranty covers your CAPRESSO machine, model #304 espresso machine. The model # can be found on the bottom of the machine. This warranty is in effect for one year from the date of the first consumer purchase. This warranty covers all defects in materials or workmanship (parts and labor).

### The warranty does NOT cover:

- Any machine not distributed by JURA CAPRESSO.
- Any machine not purchased from an Authorized JURA CAPRESSO Dealer.
- Commercial use of the machine.
- Damage caused by accident, abuse, negligence, misuse, improper operation or failure to follow instructions contained in this manual.
- Any service or alteration performed by an unauthorized person, company or association.
- Any glass parts, including the carafe.
- Any used machines bought at auctions and unauthorized websites.

### Other limitations and exclusions:

Any implied warranties including fitness for use and merchantability are limited in duration to the period of the express warranty set forth above and no person is authorized to assume for JURA CAPRESSO any other liability in connection with the sale of the machine.

JURA CAPRESSO expressly disclaims liability for incidental and consequential damages caused by the machine. The terms "incidental damages" refers to the loss of the original purchasers time, loss of the use of the machine or other costs relating to the care and custody of the machine. The term "consequential damages" refers to the cost of repairing or replacing other property which is damaged when this machine does not work properly. The remedies provided under this warranty are exclusive and in lieu of all others.

This warranty gives you specific legal rights, and you may also have other rights which vary from state to state.

## Jura Capresso, Inc.

81 Ruckman Road, PO Box 775

CLOSTER, NJ 07624

Tel 1-800-767-3554

Fax 201-767-9684

email: [contact@jura-capresso.com](mailto:contact@jura-capresso.com)

website: [www.capresso.com](http://www.capresso.com)